

The N.H. Attorney General's
Task Force on
Child Abuse and Neglect Presents:

GOING TO COURT

In New Hampshire

GOING TO COURT

Written by: Kim Fillmore
Illustrated By: Bob Freitas

The New Hampshire
Attorney General's Task Force on
Child Abuse and Neglect

This publication is a project of the ATTORNEY GENERAL'S TASK FORCE ON CHILD ABUSE AND NEGLECT. Funding for this publication was provided by the New Hampshire Department of Justice through the Children's Justice Act Grant (G-0901NHCJA1) which is administered by the United States Department of Health and Human Services - Administration on Children, Youth and Families.

This is a book all about going to court. We go to court to tell about something that we saw or heard. Sometimes we go to tell about something that happened to us.

The most important rule we have to remember when we go to court is

Always Tell the Truth.

Everybody feels something when they have to go to court. Some people feel sad, some happy, some mad, some glad, some scared, some nervous and many more feelings when they just think about going to court.

Can you draw how you feel when you think about court?

We hope that when you have finished reading this book you will feel better about going to court. It is important that you understand what is going on in court. So if you have questions make sure you ask the people who work in the court.

WHERE DOES COURT HAPPEN?

In some cities and towns there is a building called a courthouse. Inside the courthouse there are different rooms. Some of these rooms are offices for the people who work in the courthouse. Some of the rooms are called COURTROOMS.

Do you know the name of the town or city where the courthouse is?

Can you draw a picture of the courthouse?

WHAT ARE COURTROOMS?

Courtrooms are usually pretty big rooms in the courthouse where trials happen. Other kinds of things go on in a courtroom also. One of those things is called a preliminary hearing. This is a big word that means the judge and the attorneys talk about how, when and why the trial will happen.

Have you seen a courtroom yet?

Was it big or small?

Were there a lot of places to sit or not a lot?

Did you get to sit in the judge's seat?

What did you think about the courtroom?

WHO WILL BE IN THE COURTROOM?

The judge, the jury, the witness, the prosecutor, the defense attorney, the defendant, the guardian ad litem, the victim/witness advocate, the court reporter, the bailiff, the clerk of court, maybe some people in the gallery, and someone the witness would like with them for support.

This picture is what a courtroom might look like if you were sitting in the front row of the gallery,



Turn the page to find out more about all these people.

WHAT IS A JUDGE?

A judge is a man or woman with a very important job. It is the judge's job to decide what the jury can be told about what happened to you. The judge also makes sure everyone follows the rules when they are inside the courtroom. You can always tell who the judge is because they wear black robes over their clothes when they are in court. We all call the judge "your honor" when it is our turn to talk to the judge.

The judge decides what will happen to a person who admits they broke the law or is found guilty by the jury. You can tell the judge how you feel about what has happened to you. If you want to, you can tell the judge what you think should happen to the person who broke the law. How do you feel about what happened to you? Do you want to tell the judge how you feel?

THE JUDGE WANTS YOU TO

TELL THE TRUTH.

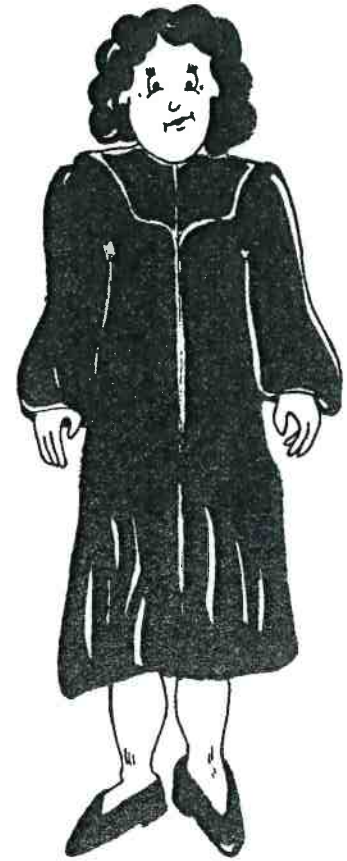

WHAT IS A JURY?

A jury is 12 OR MORE people, grown up women and men, who sit together in the courtroom. The place they sit is called a jury box. The people on a jury are called jurors. Jurors are picked by the prosecutor and the defense attorney. The job of the jury is to listen carefully to everything that the witnesses say and decide together if the state proved that the defendant is guilty or not guilty of breaking a law.

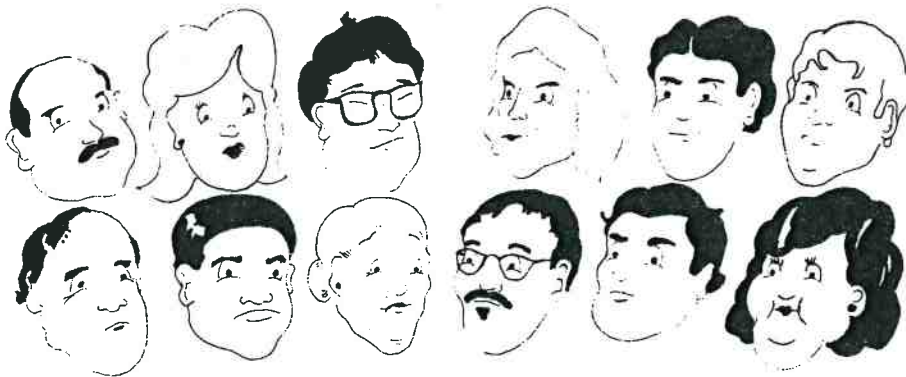

THE JURY WANTS YOU TO

TELL THE TRUTH.

WHAT IS A PROSECUTOR?

A prosecutor is a lawyer that represents the state. They are not your lawyer but they will meet with you before court and they will ask you a lot of questions about what happened to you. In New Hampshire the prosecutors are sometimes called assistant county attorneys or assistant Attorneys General. The prosecutor's job is to make sure the judge and jury know everything about what happened to you and prove that the person accused of breaking the law is the defendant. Have you met the prosecutor yet? What is his or her name?

WHAT IS A DEFENSE ATTORNEY?

A defense attorney is a lawyer who represents the defendant. The defendant is another word for the person charged with breaking the law. The defense attorney's job is to make sure that the defendant is treated in a fair way. When you go to court, the defense attorney will ask you questions after the prosecutor is finished asking you questions.

DO YOU KNOW WHAT

THE PROSECUTOR, THE G.A.L., THE ADVOCATE AND THE DEFENSE ATTORNEY ALL WANT YOU TO DO IN COURT?

IF YOU ANSWERED **TELL THE TRUTH**, YOU ARE ABSOLUTELY RIGHT!

WHAT IS A VICTIM/WITNESS ADVOCATE?

A victim/witness advocate is a person who works in the prosecutors office. Their job is to make sure that you understand all about court and how everything works. The advocate will also make sure that you and your parents or guardian know when to come to court.

WHAT IS A GUARDIAN AD LITEM?

A Guardian Ad Litem (G.A.L. for short) is a lawyer who looks out for the legal interests of a child who may be a witness. For example, if someone thinks that the jury needs to hear about your school or medical reports, your G.A.L. will get all the reports and explain to the judge if they do not think anyone needs to see the reports. The judge will decide who sees the reports.

WHO ARE THE OTHER PEOPLE IN THE COURTROOM?

COURT REPORTER

The court reporter is the person whose job is to take down everything that people say in the courtroom. Sometimes the court reporter uses a tape recording machine and sometimes they use a special typing machine that prints what looks like gobbly-gook on a long strip of paper. Don't worry though, the court reporter knows how to read the gobbly-gook from the machine. It is very important for all witnesses to speak in a loud and clear voice so the court reporter can understand what is being said. It is also important for only one person to be talking at a time. Can you think of other things a witness can do to help make the court reporter's job easier?



BAILIFF

The bailiff wears a uniform. Their job is to keep the courtroom safe. The bailiff will tell all the people in the courtroom to "please rise" whenever the judge or the jury comes into or leaves the courtroom. This means for everybody to stand up.



Have you met any bailiffs yet?

What color was their uniform?

CAN YOU HELP THE COURT REPORTER
FIND THE IMPORTANT MESSAGE
THE JUDGE SAID IN COURT?

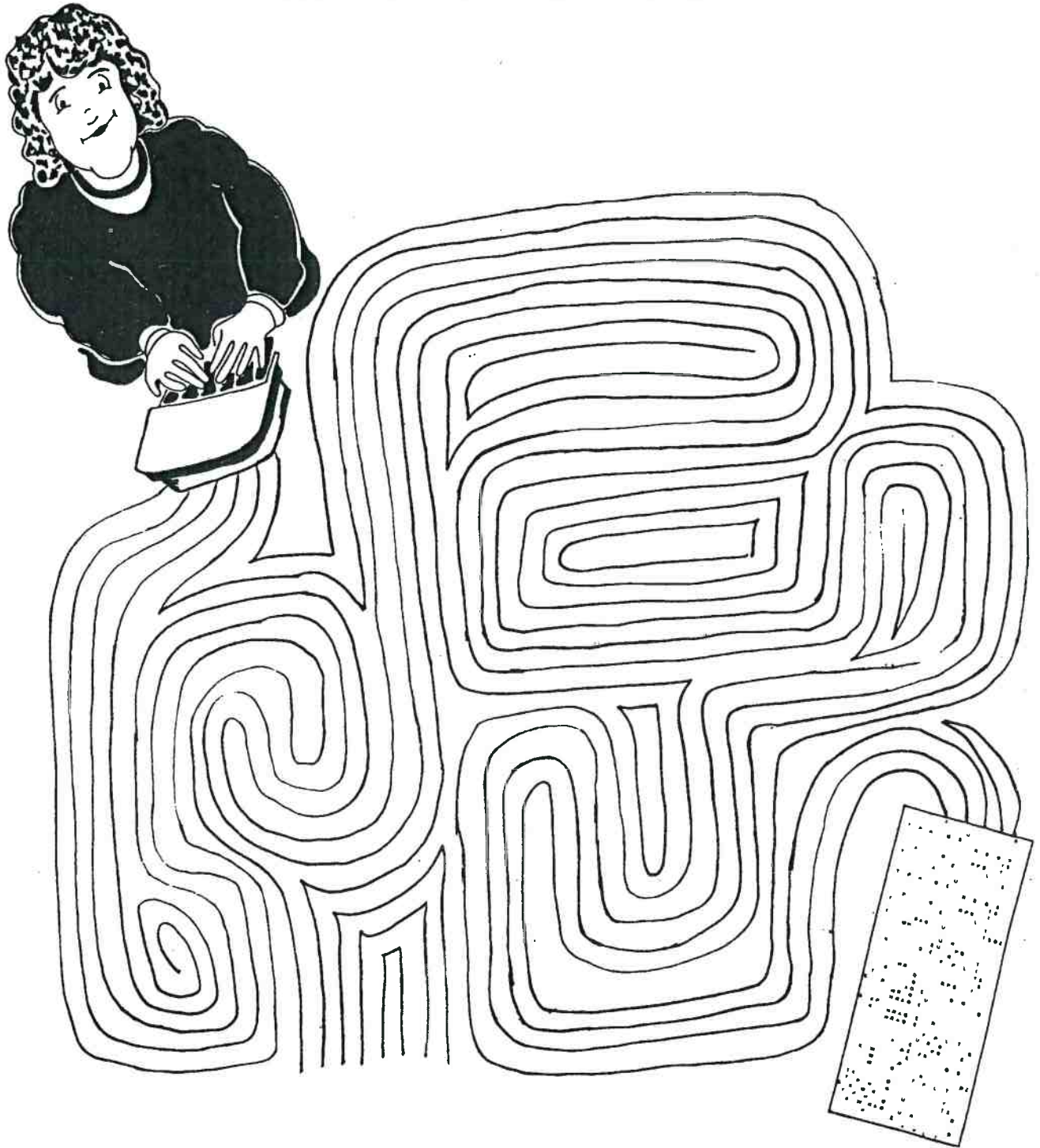

THIS IS WHAT THE COURT REPORTERS MESSAGE FROM THE JUDGE
SAYS. "AS YOU KNOW, IT IS IMPORTANT TO TELL THE TRUTH
WHEN YOU ARE IN COURT. IT IS ALSO IMPORTANT TO SPEAK
LOUDLY AND CLEARLY. YOU SHOULD ANSWER EVERY QUESTION
WITH WORDS. DO NOT JUST NOD YOUR HEAD."

CLERK OF COURT

The clerk of court sits beside the judge. Their job is to help the judge when things need to be scheduled for court. The clerk of court also reads what the defendant is being charged with before a trial begins. The clerk of court is usually not in the courtroom during the trial. Sometimes the clerk may tell all the people in the courtroom to "please rise".



PEOPLE IN THE GALLERY

Trials are open to the public which means anybody can come and watch a trial. The GALLERY is just another word for the place where people sit to watch a trial. There is usually hardly anybody who comes to watch a trial. Other people who might come in to watch could be someone learning to be a lawyer, a friend or relative of a witness or maybe someone who is waiting for their turn in another courtroom. Do you want someone to be in the courtroom with you? You can draw that person in the gallery.

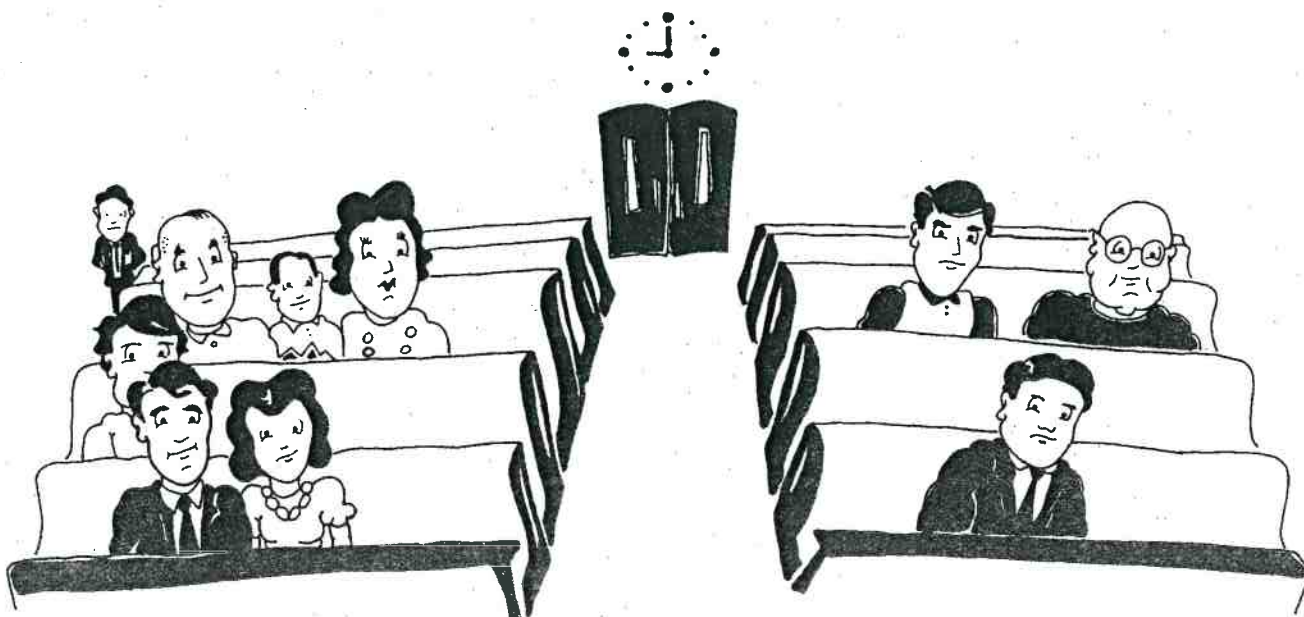



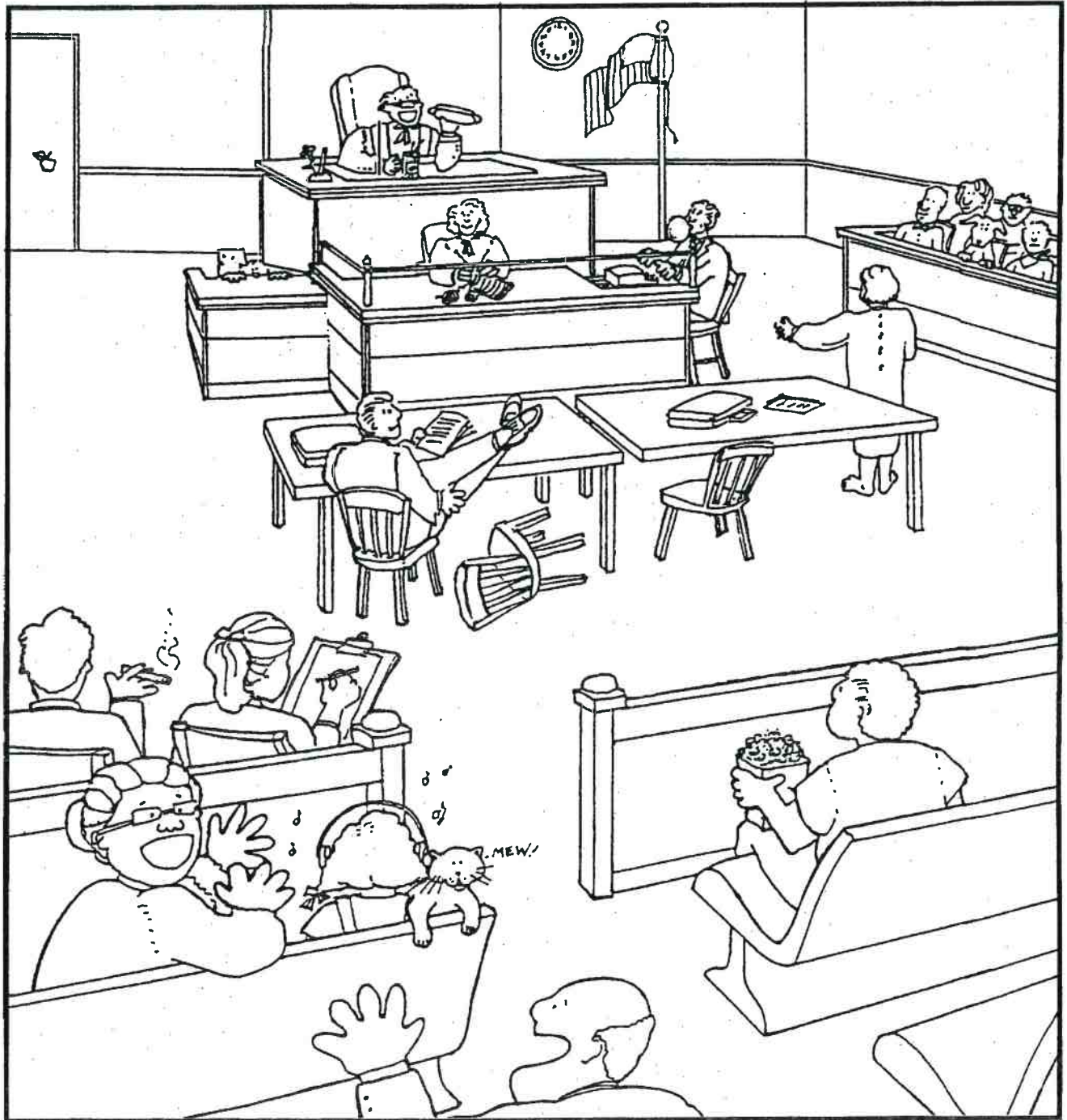

THERE ARE 20 THINGS WRONG WITH THIS PICTURE.

HOW MANY CAN YOU FIND?



WHAT DOES A WITNESS DO?

A witness is the person who answers questions about something they know. The information they know is sometimes called facts or evidence. Witnesses can talk about things they saw , heard , smelled , tasted  or felt. It is very important to listen to all questions carefully. It is important to make sure you understand what the question means before you answer the question. But, the very most important thing about being a witness is to always

TELL THE TRUTH.

WHAT DOES TESTIFY MEAN?

Testify means to speak.

When we talk about testifying in court it means to sit in the witness chair, listen carefully to any question the attorneys (and occasionally the judge) might ask and answer the question. Before a person testifies they are asked to raise their right hand and take an oath.

An oath means that we **promise to tell the truth** about whatever we are asked.

An oath might sound something like this "Do you swear to tell the whole truth and nothing but the truth so help you God."

If you agree to tell the truth you should say "Yes."

Sometimes the prosecutor might ask kids who are witnesses a lot of questions about things that have nothing to do with why they are in court.

Prosecutors do this to make sure that the judge and the jury know, that witnesses who are kids understand that they can only talk about things that are the truth.

Do you know which hand is your right hand?

Will you promise to always tell the truth in court?

FINISH THE PICTURE OF YOU PROMISING TO TELL THE TRUTH.

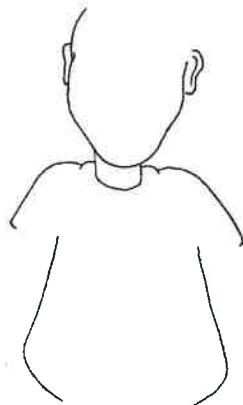

QUESTIONS KIDS ASK THE MOST

WHAT IF...

1. You are asked a question and you don't understand it?
2. You are asked a question and you can't remember the answer?
3. You are asked a question and you don't know the answer?
4. You are asked an embarrassing question?
5. You cry in court?
6. You laugh in court?
7. You need to go to the bathroom?
8. You are asked more than one question at a time?
9. You did not hear the question?
10. A lawyer says "objection" while you are testifying?
11. You feel sad or silly or mad or scared or nervous or tired or confused?

DO YOU HAVE OTHER QUESTIONS?

If you do have other questions you should ask the prosecutor, your victim/witness advocate or your G.A.L. Here is a space for you to write down any questions you want to ask.

THINGS TO DO BEFORE COURT

DRESS TO BE NEAT AND COMFORTABLE



GO TO THE BATHROOM

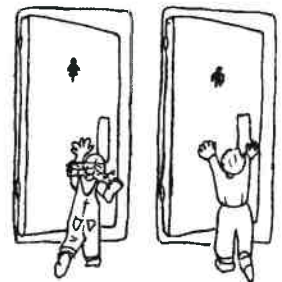

EAT A HEALTHY SNACK
(CIRCLE THE HEALTHY SNACKS)



WHAT IS A TRIAL?

A trial happens in a courtroom. This is when the prosecutor shows the jury why they believe the defendant is guilty of breaking a law. The prosecutor shows the jury by having different witnesses testify. The defense attorney also asks the same witnesses a lot of questions about what they know.

When the prosecutor is finished with all of their witnesses, the defense attorney may bring other witnesses in to court to try to show the jury that the prosecutor can't prove the defendant is guilty. The prosecutor gets to ask all of the witnesses the defense attorney brings to court questions also.

After the prosecutor and the defense attorney have finished asking questions of all the witnesses, the judge will tell the jury about the law. When the judge is done telling about the law the jurors will go into a room by themselves to DELIBERATE.

WHAT DOES DELIBERATE MEAN?

Deliberate is a big word that means the jurors are talking about everything they heard in the trial. They have to decide if the defendant is guilty or not guilty. The jurors have a very hard job, like putting the pieces of a really hard puzzle together. Sometimes the jurors may be confused because some of the pieces are missing and other pieces are not clear. The jurors ALL have to feel **POSITIVELY SURE** that the defendant broke the law before they can say the defendant is **GUILTY**. If they are all not positively sure then the jurors are told they must find the defendant not guilty.

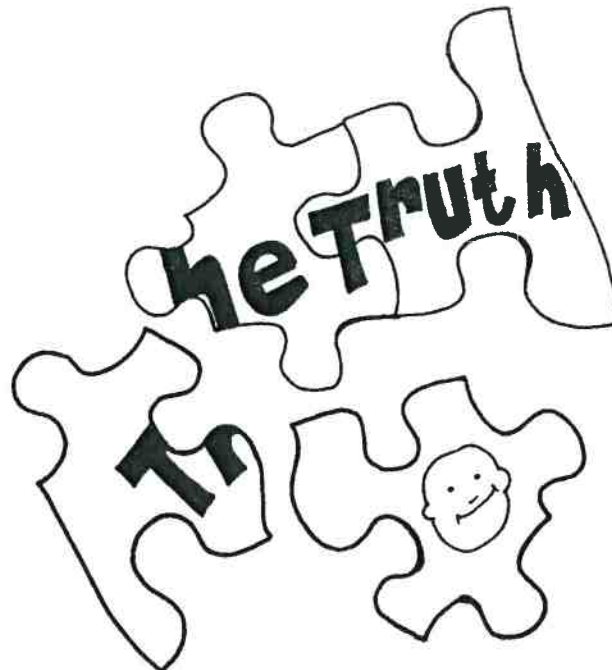

WHAT HAPPENS AFTER I TESTIFY?

Some kids just want to go home or back to school after they testify. Some kids want to stay in the courthouse with their mom and dad to see what the jury decides. You don't have to decide what you will do until after you testify.

house school courthouse friend relative ?

If the jury finds the defendant not guilty of breaking the law, then the defendant is free to go. If the jury finds the defendant guilty of breaking the law then the judge will decide how to help the defendant not to break the law again. You can tell the judge your feelings in a letter or outloud. If you don't want to read the letter yourself, you can just let the judge read it or someone else can read it for you. You can tell your mom or dad, the prosecutor or guardian ad litem or the victim/witness advocate how you feel, and that person can tell the judge how you feel.

**IT IS VERY IMPORTANT TO REMEMBER,
AS LONG AS YOU TOLD THE TRUTH IN
COURT ABOUT WHAT HAPPENED, YOU
SHOULD BE PROUD!**

Can you
draw a
picture of
yourself
feeling
PROUD?

NOW THAT YOU KNOW WHO EVERYBODY IS AND YOU HAVE SEEN A COURTROOM LET'S SEE IF YOU CAN PLACE EVERYBODY IN THEIR RIGHT SEAT.

Write the number in the circle where that person or persons should sit.

- | | |
|-----------------------------|-------------------------------|
| 1. JUDGE | 2. JURY |
| 3. WITNESS | 4. BAILIFF |
| 5. PROSECUTOR | 6. DEFENSE ATTORNEY |
| 7. CLERK OF COURT | 8. COURT REPORTER |
| 9. GUARDIAN AD LITEM | 10. VICTIM/WITNESS ADVOCATE |
| 11. MOM, DAD OR OTHER ADULT | 12. PEOPLE COMING IN TO WATCH |
| 13. YOUR FAVORITE PET | |

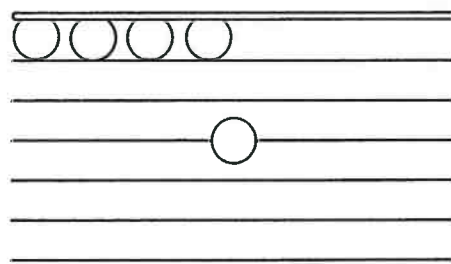
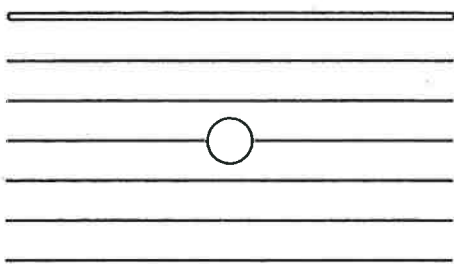
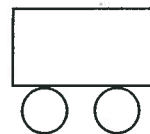
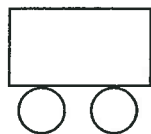
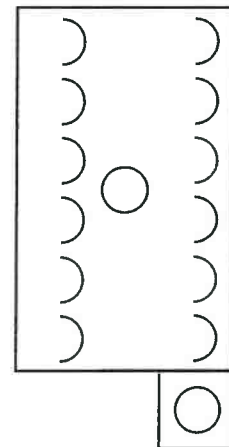
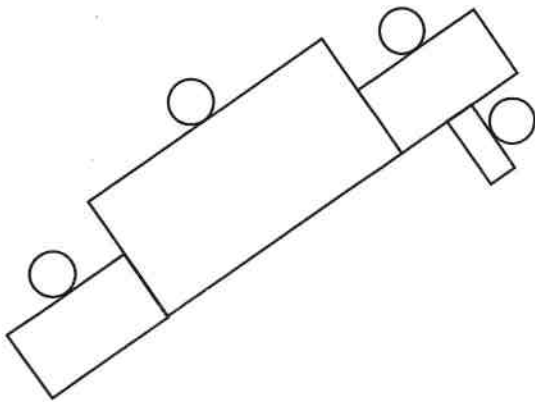

I bet you knew not to put your favorite pet in the courtroom
Because pets are not allowed in court.

FIND THE WORD

There are 35 words hidden in this puzzle. The words may be hidden across, up and down and diagonally. Most of these words can be found throughout this book. You might find a couple of new words, if you do, make sure to ask what they mean if you do not already know. When you find a word, circle it and cross it off the list. You can find the answers on page 18. (Do not peek, unless you really can not find a word).



ALWAYS TELL THE TRUTH • BAIL • BAILIFF • CHARGE • CLERK • COURTROOM • DEFENSE ATTORNEY • DELIBERATE • EVIDENCE • GALLERY • GUARDIAN AD LITEM • GUILTY • JUDGE • JUROR • JURY BOX • MOTION • NOT GUILTY • OATH • OBJECT • PLEA • PLEASE RISE • PRELIMINARY • PROSECUTOR • PROUD • QUESTIONS • REPORTER • RESPECT • RIGHT • SENTENCE • STATEMENT • SUBPOENA • TESTIFY • TRUTH • VICTIM ADVOCATE • WITNESS

THIS IS A CHART THAT SHOWS WHAT HAPPENS FROM START TO FINISH.

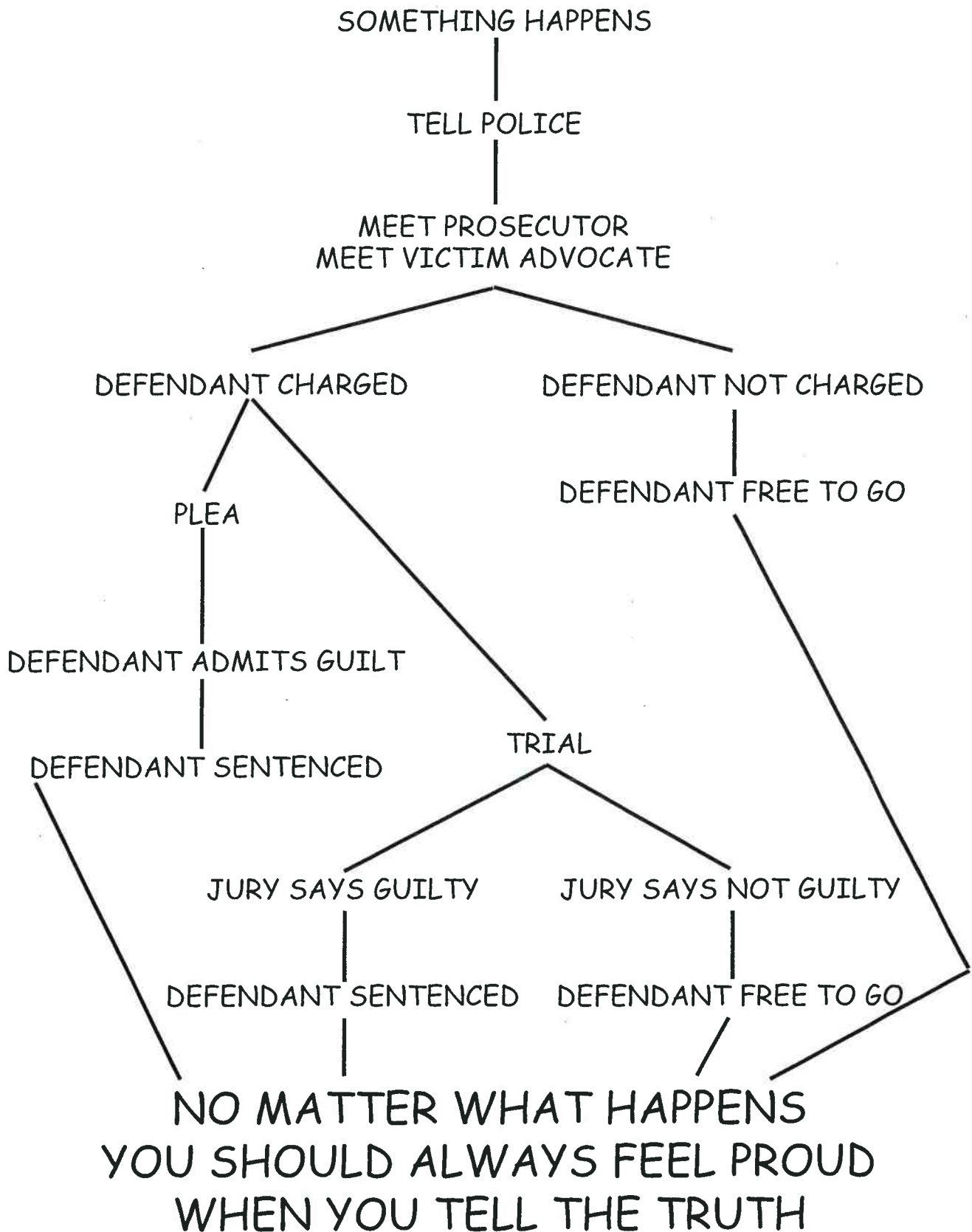

ANSWER PAGE

COURT REPORTERS MAZE

20 THINGS THAT ARE WRONG

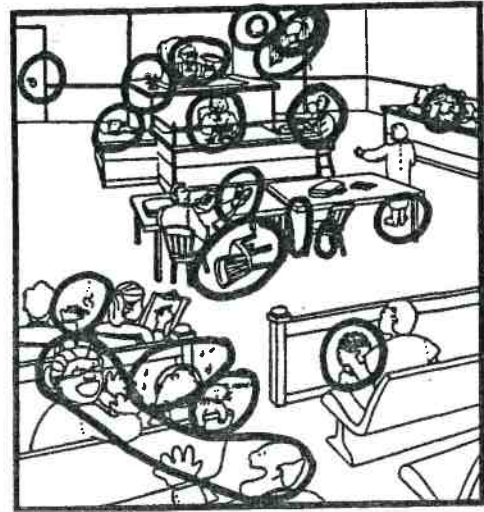

WHAT IF...

1. You are asked a question and you don't understand it? · Tell the person asking the question that you don't understand.
2. You are asked a question and you can't remember the answer? · Tell the truth that you don't remember, do not make up an answer.
3. You are asked a question and you don't know the answer? · Tell the truth that you don't know, do not make up an answer.
4. You are asked an embarrassing question? · Sometimes it is necessary to ask embarrassing questions in court, it is important that you do the best you can to answer every question even if it embarrasses you.
5. You cry in court? · It is okay if you cry in court, if you need a break you should ask for one. If someone asks you if you want to take a break, but you do not want to, you should say so.
6. You laugh in court? · Going to court is a serious thing, sometimes people laugh when they are nervous or scared. If this happens to you, you should explain why you are laughing.
7. You need to go to the bathroom? · If you need to go to the bathroom, you should ask for a short break.
8. You are asked more than one question at a time? · If you are able to understand & remember what is being asked then you should answer the questions. If not then you should ask the person to ask the questions one at a time.
9. You did not hear the question? · If you did not hear the question you should ask the person to repeat it.
10. A lawyer says "objection" while you are testifying? · If a lawyer says "objection" you should stop talking right away. After the lawyers talk to the judge someone, probably the judge or prosecutor will tell you if you should answer the question or not answer it.
11. You feel sad or silly or mad or scared or nervous or tired or confused? · Feelings are not right or wrong, they just are. You just need to try to answer the question the best you can. And if you need help it is okay to ask right then.

WHERE DOES EVERYBODY SIT?

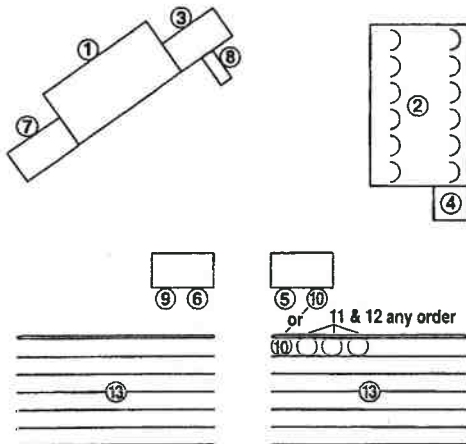

WORD FIND

